

ILD205T/206T/207T/211T/213T/217T

Dual Phototransistor

Small Outline Surface Mount Optocoupler

FEATURES

- Two Channel Coupler
- SOIC-8A Surface Mountable Package
- Standard Lead Spacing of .05"
- Available only on Tape and Reel Option (Conforms to EIA Standard 481-2)
- Isolation Test Voltage, 3000 V_{RMS}
- High Current Transfer Ratios
 ILD205T, 40 – 80%
 ILD206T, 63 –125%
 ILD207T, 100 – 200%
 ILD211T, 20% Minimum
 ILD213T, 100% Minimum
 ILD217T, 100% Minimum at 1.0 mA
- High BV_{CEO}, 70 V
- Compatible with Dual Wave, Vapor Phase and IR Reflow Soldering
- Underwriters Laboratory File #E52744 (Code Letter Y)

DESCRIPTION

The ILD205T/206T/207T/211T/213T/217T are optically coupled pairs with a Gallium Arsenide infrared LED and a silicon NPN phototransistor. Signal information, including a DC level, can be transmitted by the device while maintaining a high degree of electrical isolation between input and output. The ILD205T/6T/7T/11T/13T/17T come in a standard SOIC-8A small outline package for surface mounting which makes it ideally suited for high density applications with limited space. In addition to eliminating through-holes requirements, this package conforms to standards for surface mounted devices. A specified minimum and maximum CTR allows a narrow tolerance in the electrical design of the adjacent circuits. The high BV_{CEO} of 70 volts gives a higher safety margin compared to the industry standard of 30 volts.

Maximum Ratings (Each Channel)

Emitter

Peak Reverse Voltage 6.0 V
 Peak Pulsed Current (1.0 μs, 300 pps) 1.0 A
 Continuous Forward Current per Channel 30 mA
 Power Dissipation at 25°C 50 mW
 Derate Linearly from 25°C 0.66 mW/°C

Detector

Collector-Emitter Breakdown Voltage 70 V
 Emitter-Collector Breakdown Voltage 7.0 V
 Power Dissipation per Channel 125 mW
 Derate Linearly from 25°C 1.67 mW/°C

Package

Total Package Dissipation at 25°C Ambient
 (2 LEDs + 2 Detectors, 2 Channels) 300 mW
 Derate Linearly from 25°C 4.0 mW/°C
 Storage Temperature -55°C to +150°C
 Operating Temperature -55°C to +100°C
 Soldering Time at 260°C 10 sec.

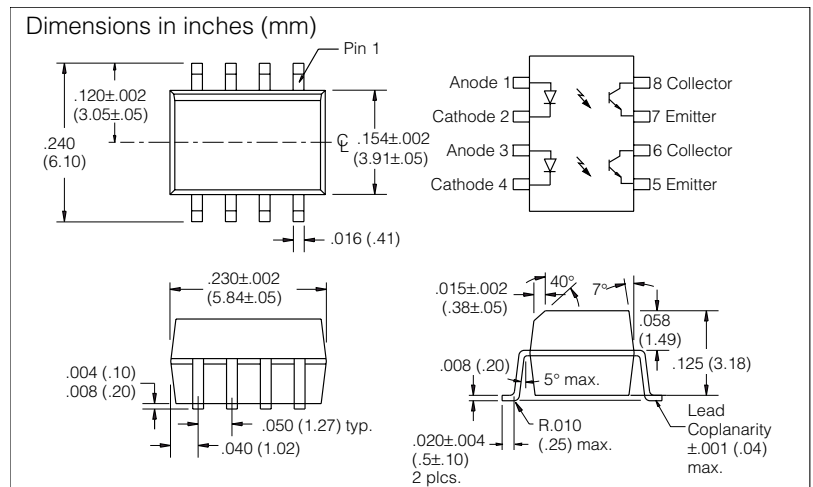

Table 1. Characteristics $T_A=25^\circ\text{C}$

Parameter	Min.	Typ.	Max.	Unit	Condition
Emitter					
Forward Voltage	—	1.2	1.55	V	$I_F=10\text{ mA}$
Reverse Current	—	0.1	100	μA	$V_R=6.0\text{ V}$
Capacitance	—	25	—	pF	$V_R=0$
Detector					
Breakdown Voltage	BV _{CEO}	70	—	—	V $I_C=10\text{ μA}$
	BV _{ECO}	7.0	—	—	V $I_E=10\text{ μA}$
	I _{CEO}	—	5.0	50	nA $V_{CE}=10\text{ V}$ $I_F=0$
Collector-Emitter Capacitance	—	10	—	pF	$V_{CE}=0$
Package					
DC Current Transfer, $V_{CE}=5.0\text{ V}$	ILD205	40	—	80	% $I_F=10\text{ mA}$
	ILD206	63	—	125	
	ILD207	100	—	200	
	ILD211	20	—	—	
	ILD213	100	—	—	
	ILD205	13	30	—	$I_F=1.0\text{ mA}$
	ILD206	22	45	—	
Collector-Emitter Saturation Voltage $V_{CE(sat)}$	ILD207	34	70	—	V $I_F=10\text{ mA}$ $I_C=2.5\text{ mA}$
	ILD217	100	120	—	
	Collector-Emitter Saturation Voltage $V_{CE(sat)}$	—	—	0.4	V
Capacitance, Input to Output	—	0.5	—	pF	—
Isolation Test Voltage	3000	—	—	V _{RMS}	t=1.0 sec.
Resistance, Input to Output	—	100	—	GΩ	—
Turn-on Time	—	5.0	—	μs	$I_C=2.0\text{ mA}$ $R_L=100\text{ Ω}$ $V_{CC}=5.0\text{ V}$
Turn-off Time	—	4.0	—	μs	

Figure 1. Forward current versus forward voltage

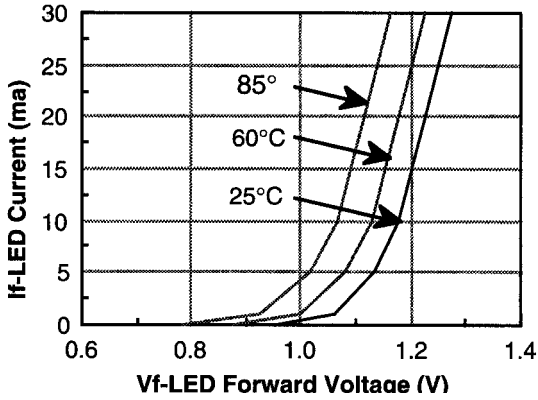

Figure 2. Collector-emitter current versus temperature

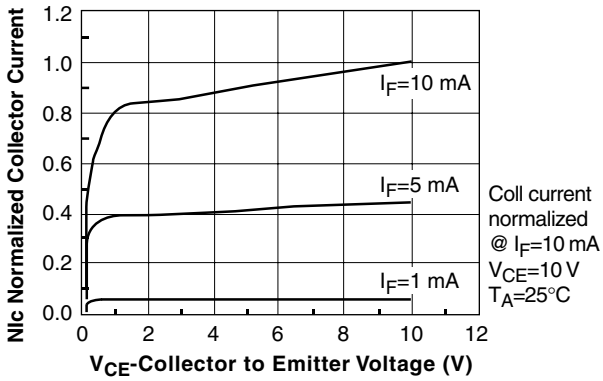

Figure 3. Normalized CTR_{ce} versus forward current

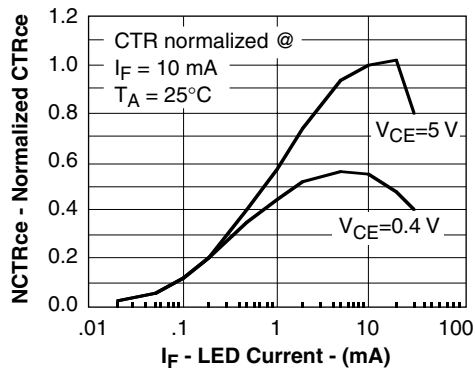

Figure 4. CTR (normalized) versus temperature

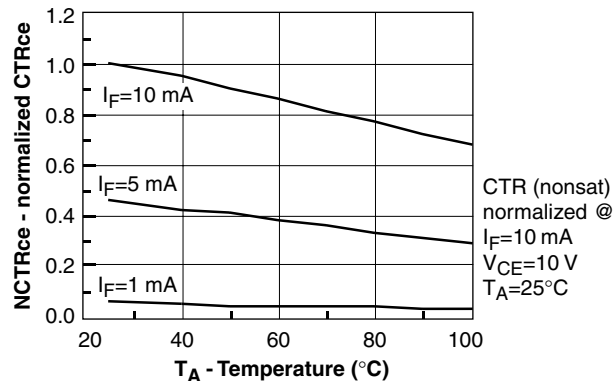

Figure 5. Switching speed versus load resistor

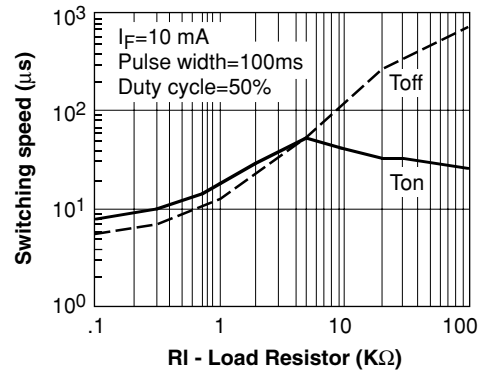

Figure 6. Collector current versus temperature

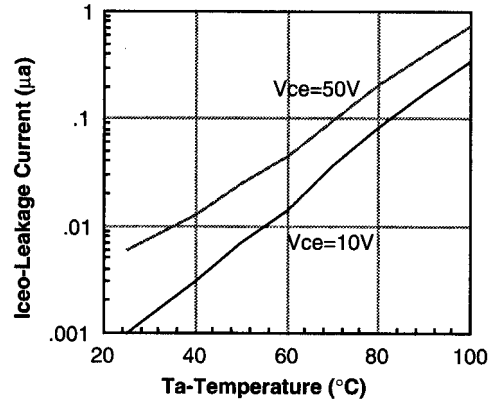

Figure 7. Power dissipation versus ambient temperature

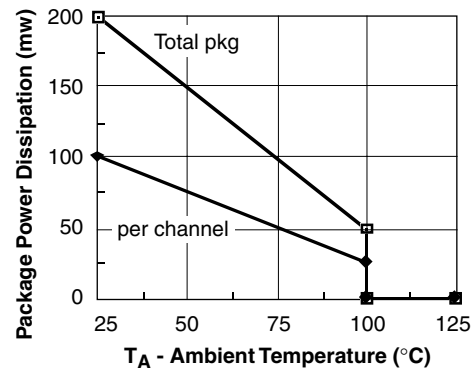

Figure 8. Switching time test schematic and waveform

